

Article number: 209077451

Description: E+G Ball point screw
GN 605-M16-20-VNR

Measures

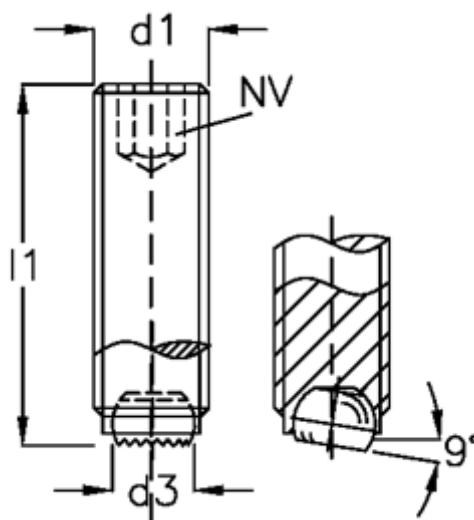

d1	= M16
d2	= 12.0
d3	= 10.7
Internal hexagon	= 8
l1	= 20